

3i-3021-18BC

HARDERBACK

Maletas Industriales | Maletines Militares
Estuches de Protección | Cajas Polipropileno
Mochilas Resistentes | Cajas Biometricas



Colores



Especificaciones (Largo x Ancho x Profundo)

Exterior:

[32.94" x 23.53" x 18.87"]
[83.67 x 59.77 x 47.93 cm]

Interior:

[30.00" x 21.00" x 18.00"]
[76.20 x 53.34 x 45.72 cm]

Peso:

[37.00 lb] [16.78 kg]

Certificaciones

MIL-C-4150J / MIL-STD-810F
/ MIL-STD-648C

[Características]

SKB iSeries Moldeado por inyección Mil-Standard
Los estuche impermeables están moldeados de resina de copolímero de polipropileno de muy alta resistencia

- Diseño resistente al agua y al polvo
- Convenientes ruedas de deslizamiento silencioso
- Resistente a los Rayos UV disolventes, corrosión, hongos (MIL-STD-810F).
- Válvula de equalización de presión ambiente
- Resistente al daño por impacto (MIL-STD-810F).
- Bisagra moldeada para mayor protección

[Configuraciones]

- Sin Foam, Vacio
- Con Foam precortado

[Accesorios]

- [3SKB-BB61
 - Bolsillo con medidas 20" x 15.5" x 3"
- [1SKB-PDL-C
 - Candado con cable SKB TSA
- [3i-TSA-3
 - Cada kit incluye 2 pestillos de bloqueo TSA, pasadores de repuesto y 2 llaves.
- [3i-PMCK
 - Panel Mount Clip Kit para los case de la serie 3i
- [3SKB-SLP kit
 - Mide 12" x 7" (30.48 x 17.78 cm)



[3SKB-BB61]



[1SKB-PDL-C]



[3i-TSA-3]



[3i-PMCK]



[1SKB-PDL]



[3SKB-SLP kit]

[Mexico D.F] 55.8851.8726 - 55.8851.8725
[Querétaro] 442.234.1610 - 442.234.1338
www.harderback.com

HARDERBACK

3i-3021-18BC

HARDERBACK

Maletas Industriales | Maletines Militares
Estuches de Protección | Cajas Polipropileno
Mochilas Resistentes | Cajas Biometricas

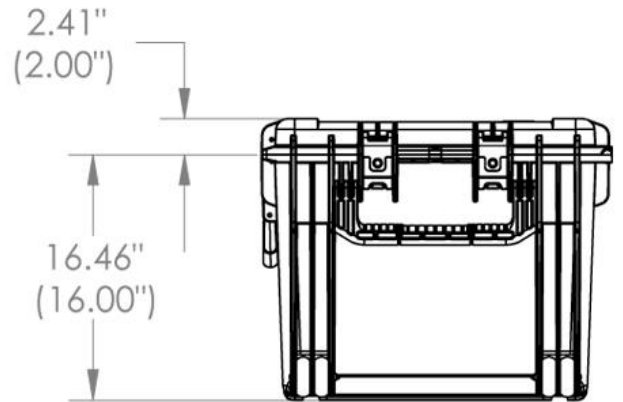
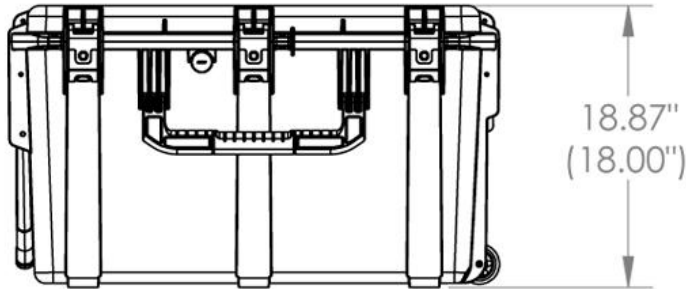
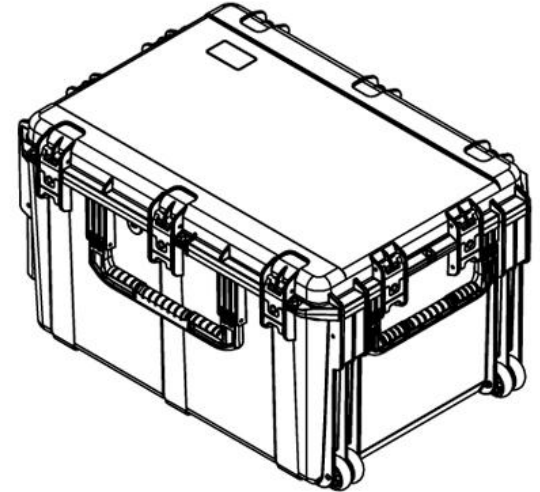
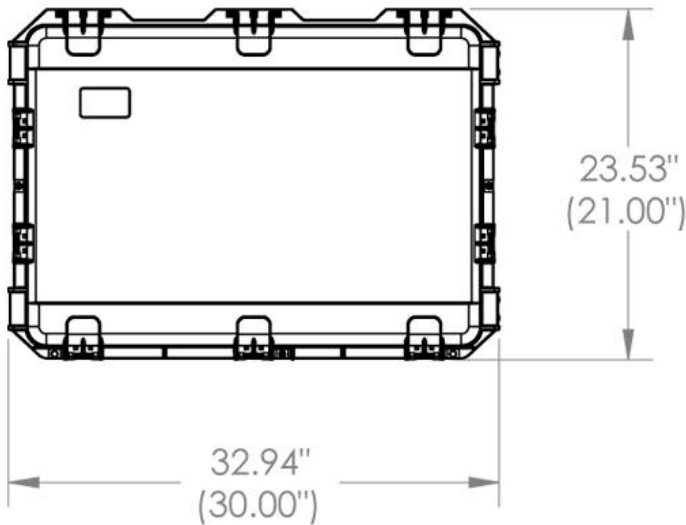

3i-3021-18

NOTE: DIMENSIONS IN (X.XX) ARE ID

Case Series:	3i Series	Dimensions (for reference only)				
Case part#	3i-3021-18		Length	Width	Overall	Base / Lid
			left to right	front to back	height	height
Weight:		Exterior	32.94"	23.53"	18.87"	16.46"/2.41"
		Interior	30.00"	21.00"	18.00"	16.00"/2.00"